

Top Rail



Baluster



Porch Post

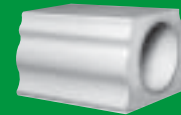

Bottom Rail



Newel Post

DEFINE YOUR BOUNDARIES.

This design accent is excellent for defining living space, indoors and out. With Pacific Columns Balustrade Systems, you can transform an ordinary porch into an impressive statement of design and sophistication. You can also make patios, balconies and stairways more inviting with the distinctive styles and sizes available. Balustrades are made up of non-corrosive parts that keep their beauty with little maintenance. Most fasteners remain totally hidden to provide a clean, classic appearance from any view. And all parts are composed of the same durable urethane material featured in all our products. To meet structural requirements, baluster rails, newels and porch posts are reinforced. For easy installation and ordering, complete systems are available with all the essential components.

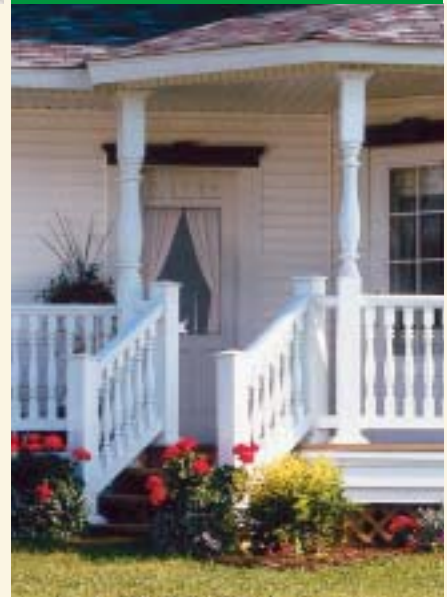

HOW TO ORDER BALUSTRADE SYSTEMS.

SAMPLE CHART

**5" Balustrade System
Baluster - Classic (CC)**

Part Number	Maximum Center-to-Center Distance To Meet 4" Rule. <small>(See Page 2 BL For Details)</small>
NEW BAL3X20CC	5"

The 4" Ball Space Requirement Rule—

gives you the *maximum* center-to-center distance between Balusters and still does not allow a 4" Ball to pass through at any point between the Balusters.

When laying out Balusters, use the maximum center to center dimension or smaller to allow for a safe dimension to pass the 4" ball space requirement rule.

KEY POINTS TO REMEMBER

- This Balustrade section/catalog is divided into four systems: 5", 6", 7" & 12". This number designates the width of the Top and Bottom Rail. When choosing balustrade components, choose items within the same system to ensure they will all work together.
- All part numbers are alphanumeric—the "alpha" is product descriptive and the "numeric" relates to size.

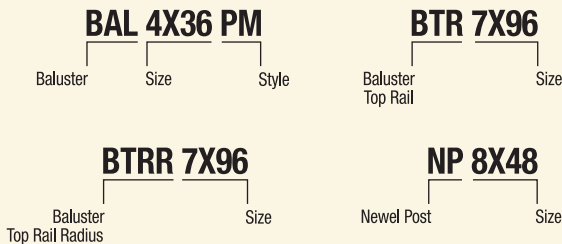

- The number of Balusters you need can be found by dividing the rail span, in inches, by the maximum center-to-center distance shown for the Baluster style that you choose. **NOTE: When dividing gives you a fractional result, always round up to the next whole number.**

Example: BAL3X20CC - requires 5" on center spacing

Rail Span ÷ Center Spacing = # of Balusters Needed

$$96" \div 5" = 20$$

- Each rail section (span between two Newel Posts) will require two Rail Installation Kits (BRK). Rail Installation Kits will connect both ends of one rail to a Newel Post. **NOTE: The Rail Installation Kit will not work on stair applications.**
- Each Newel Post will require one Newel Post Installation Kit (NPK) to anchor the base of the post, as well as any Post Tops, Balls or Trim Collars desired.
- Top and Bottom Rails do not come pre-drilled.
- A urethane-based adhesive such as PL Premium must be used on all joints.
- For installation instructions, refer to the back of the comprehensive, full-line product catalog or visit www.pacificcolumns.com.
- Balustrade Systems may require additional shipping time, depending on the style of product and size of order.
- Pacific Columns Balustrade Systems have been tested and meet the following BOCA National Building Code/1993 Criteria if assembled according to manufacturer's guidelines.
 - 1615.8.2 Guard Design and Construction
 - 1615.8.2.1 In-Fill Areas



5" BALUSTRADE SYSTEM

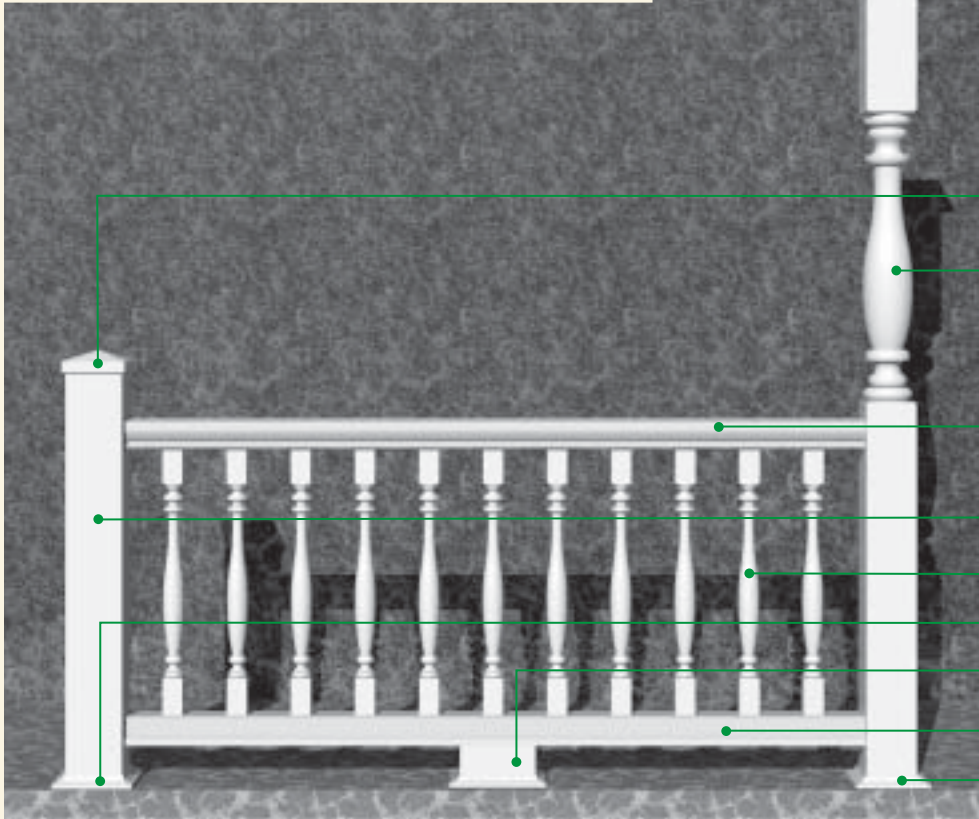

PPK6 Porch Post Mounting Kit with Trim Collar

PST7X7P Post Top - Peaked

PP6X96 Porch Post

BTR5X96 Baluster Top Rail

NP6X48 Newel Post

BAL3X32AY Baluster

TC6 Trim Collar

RSB4X4X6 Rail Support Block

BBR5X96 Baluster Bottom Rail

PPK6 Porch Post Mounting Kit with Trim Collar

BAL3X32AY
Baluster Reinforced



BTR5X96
Baluster Top Rail Reinforced

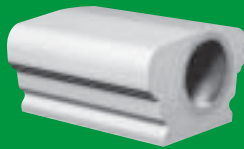

BBR5X96
Baluster Bottom Rail Reinforced

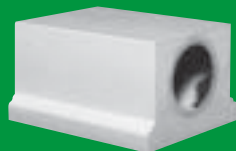

NP6X48
Newel Post Reinforced



PP6X96
Load-bearing Porch Post Reinforced



5" Balustrade System Baluster - Ashley (AY)

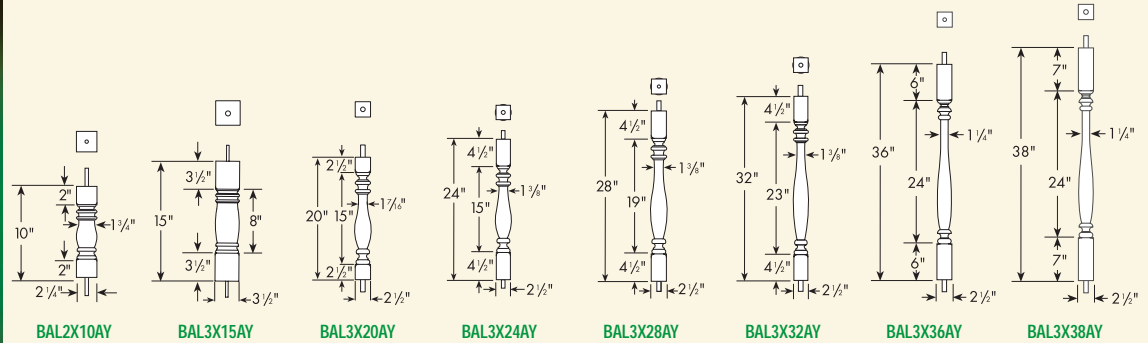

Part Number

Maximum Center-to-Center Distance To Meet 4" Rule.
(See Page 2 BL For Details)

BAL2X10AY	5 7/8"	<i>Ideal for Porch Spandrel application.</i>
BAL3X15AY	5 11/16"	
NEW BAL3X20AY	5 3/8"	
BAL3X24AY	5 7/16"	
BAL3X28AY	5 5/16"	
BAL3X32AY	5 5/16"	
BAL3X36AY	5 3/16"	
BAL3X38AY	5 3/16"	

5" Balustrade System Baluster - Classic (CC)

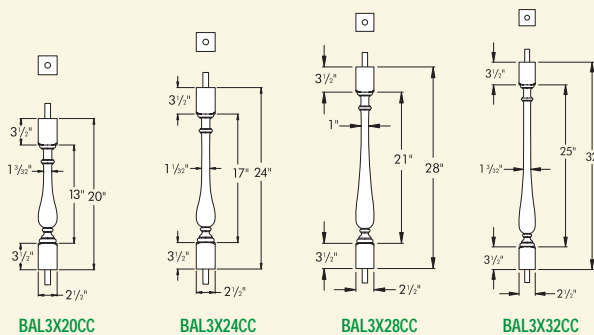

Part Number

Maximum Center-to-Center Distance To Meet 4" Rule.
(See Page 2 BL For Details)

NEW BAL3X20CC	5"	
NEW BAL3X24CC	5"	
NEW BAL3X28CC	4 15/16"	
NEW BAL3X32CC	5"	



5" Balustrade System Baluster - Logan (LN)

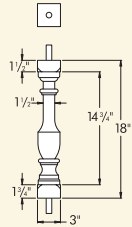

BAL3X18LNOB*

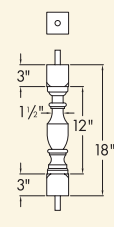

BAL3X18LN

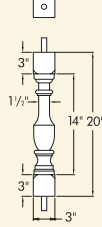

BAL3X20LN

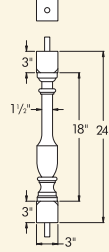

BAL3X24LN

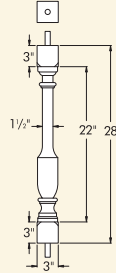

BAL3X28LN

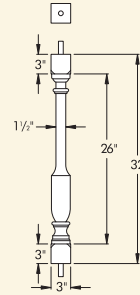

BAL3X32LN

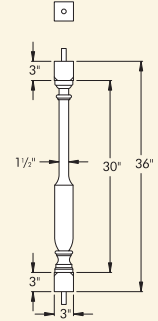

BAL3X36LN

Part Number Maximum Center-to-Center Distance To Meet 4" Rule.
(See Page 2 BL For Details)

BAL3X18LNOB*	5 7/16"	
NEW BAL3X18LN	5 7/16"	
NEW BAL3X20LN	5 7/16"	
NEW BAL3X24LN	5 7/16"	
NEW BAL3X28LN	5 7/16"	
NEW BAL3X32LN	5 7/16"	
NEW BAL3X36LN	5 7/16"	

*Cannot be used for stair applications.

5" Balustrade System Baluster - Rosedale (RL)

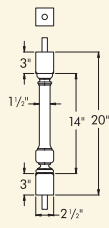

BAL3X20RL

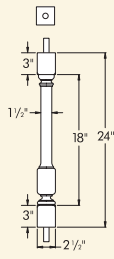

BAL3X24RL

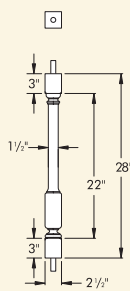

BAL3X28RL

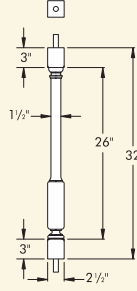

BAL3X32RL

Part Number Maximum Center-to-Center Distance To Meet 4" Rule.
(See Page 2 BL For Details)

NEW BAL3X20RL	5 7/16"	
NEW BAL3X24RL	5 7/16"	
NEW BAL3X28RL	5 7/16"	
NEW BAL3X32RL	5 7/16"	



5" Balustrade System Baluster - Square (SQ)

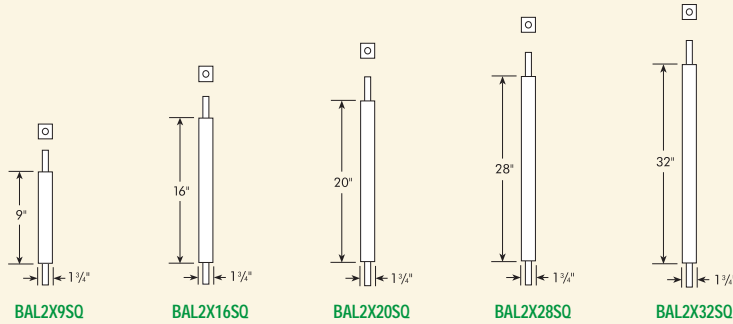

Part Number Maximum Center-to-Center Distance To Meet 4" Rule.
(See Page 2 BL For Details)

NEW BAL2X9SQ	5 11/16"	
BAL2X16SQ	5 11/16"	
BAL2X20SQ	5 11/16"	
BAL2X28SQ	5 11/16"	
BAL2X32SQ	5 11/16"	

5" Balustrade System Baluster - Woodruff (WF)

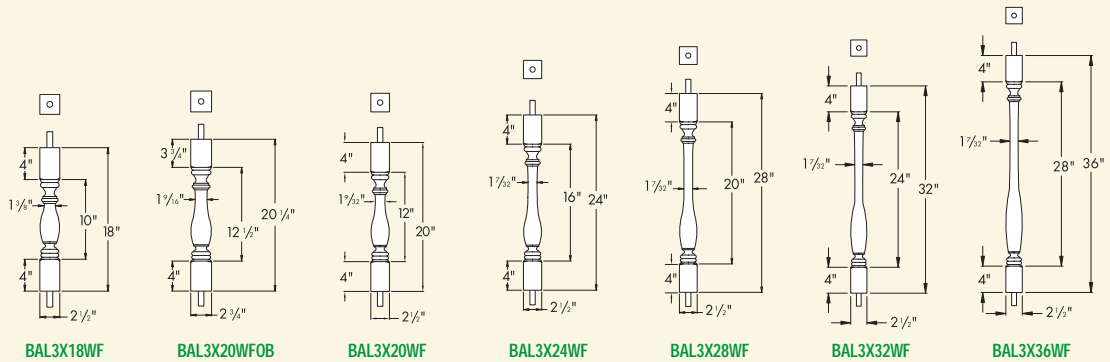

Part Number Maximum Center-to-Center Distance To Meet 4" Rule.
(See Page 2 BL For Details)

NEW BAL3X18WF	5 9/16"	
BAL3X20WFOB	5 1/2"	
NEW BAL3X20WF	5 7/32"	
NEW BAL3X24WF	5 3/16"	
NEW BAL3X28WF	5 3/16"	
NEW BAL3X32WF	5 3/16"	
NEW BAL3X36WF	5 1/8"	

5" Balustrade System Top Rail

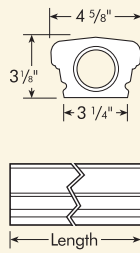

Part Number	Length	Baluster Rail Installation Kit* <small>(See Installation Guide Page 32)</small>	
BTR5X96	96"	BRK5	
BTR5X144 <small>Note: Max. rail span distance for field applications is 96"</small>	144"	BRK5	

*Connects both ends of one 5" Rail to applications.
May be used for corner or butt connections into NP6X48 or PP6X96.
(2 qty.) 2" wide x 1 1/2" x 2" Angle Brackets.
(6 qty.) #14 x 2 1/2" Stainless Steel Flat Head Screws.

5" Balustrade System Bottom Rail

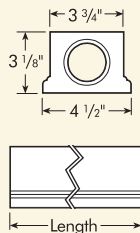

Part Number	Length	Baluster Rail Installation Kit* <small>(See Installation Guide Page 32)</small>		Rail Support Block <small>(See Below)</small>
BBR5X96	96"	BRK5		RSB4X4X6
BBR5X144 <small>Note: Max. rail span distance for field applications is 96"</small>	144"	BRK5		RSB4X4X6

*Connects both ends of one 5" Rail to applications.
May be used for corner or butt connections into NP6X48 or PP6X96.
(2 qty.) 2" wide x 1 1/2" x 2" Angle Brackets.
(6 qty.) #14 x 2 1/2" Stainless Steel Flat Head Screws.

5" Balustrade System Rail Support Block

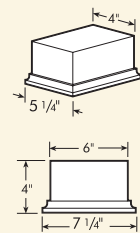
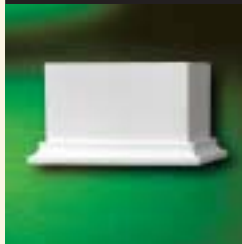

Part Number	
RSB4X4X6	

Rail Support Blocks should be placed under the Bottom Rail at a span of every 48" or less. These blocks can be trimmed for height.

5" Balustrade System Baluster Top Rail Radius

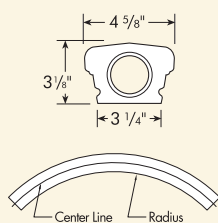

Part Number	Radius	Center Line Length	Baluster Rail Installation Kit* <small>(See Installation Guide Page 32)</small>	
NEW BTRR5X36	36"	56" (1/4 Circle)	BRK5	
NEW BTRR5X60	60"	98" (1/4 Circle)	BRK5	
NEW BTRR5X155	155 1/2"	122" (1/8 Circle)	BRK5	

*Connects both ends of one 5" Rail to applications.
May be used for corner or butt connections into NP8X48 or PP8X96.
(2 qty.) 4" wide x 1 1/2" x 2" Angle Brackets.
(8 qty.) #14 x 2 1/2" Stainless Steel Flat Head Screws.



5" Balustrade System Baluster Bottom Rail Radius

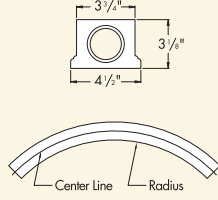

Part Number	Radius	Center Line Length	Baluster Rail Installation Kit* (See Installation Guide Page 32)	Rail Support Block (Page 7 BL)
NEW BBRR5X36	36"	56" (1/4 Circle)	BRK5	RSB4X4X6
NEW BBRR5X60	60"	98" (1/4 Circle)	BRK5	RSB4X4X6
NEW BBRR5X155	155 1/2"	122" (1/8 Circle)	BRK5	RSB4X4X6

*Connects both ends of one 5" Rail to applications.
May be used for corner or butt connections into NP8X48 or PP8X96.
(2 qty.) 4" wide x 1 1/2" x 2" Angle Brackets.
(8 qty.) #14 x 2 1/2" Stainless Steel Flat Head Screws.

5" Balustrade System Porch Post

Post is load bearing and reinforced.*

DIMENSIONS

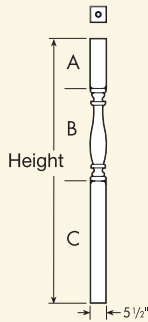

Part Number	Height	A	B	C	Porch Post Installation Kit** (See Installation Guide Page 32)	Load Rating/Dead Load
PP6X96	96"	18"	33 9/16"	47 7/16"	PPK6	3000#
NEW PP6X108	108"	21"	42 1/2"	44 1/2"	PPK6	9000#
NEW PP6X120	120"	26"	49 1/2"	44 1/2"	PPK6	9000#

*Porch Post can be field trimmed to various heights without losing load rating.
**Hardware included to secure one PP6X96.
(2 qty.) 5 1/2" x 5 1/2" Trim Collars (TC6).
(4 qty.) 2" wide x 1 1/2" x 2" Angle Brackets.
(12 qty.) #14 x 2 1/2" Stainless Steel Flat Head Screws.
Fasteners to mount angle brackets to floor surface not provided.

5" Balustrade System Newel Post



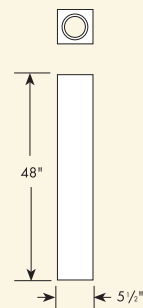



One piece Post reinforced, height trimable.

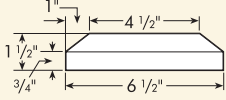

Part Number	Newel Post Installation Kit* (See Installation Guide Page 32)
NP6X48	NPK6

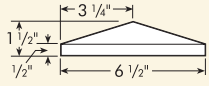
*Hardware included to secure one NP6X48.
(2 qty.) 3/8" - 16 Hex Nuts.
(2 qty.) 3/8" - Lock Washers.
(2 qty.) 3/8" - Flat Washers.
(1 qty.) 1/4" x 4 1/2" Diameter Steel Top Mounting Plate.
(2 qty.) 3/8" x 50" Threaded Rods.
(1 qty.) 1/4" x 3 1/2" x 3 1/2" Octagon Steel Base Plate.
Fasteners to mount Steel Base Plate to floor surface not provided.

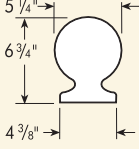
5" Balustrade System
Newel Post Accessories

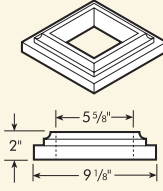
		Part Number	Coordinating Newel Post Accessories	
		PST7X7F Post Top - Flat	B5X7	
		PST7X7P Post Top - Peaked	—	
		B5X7 Ball	PST7X7F	
		TC6 Base Trim Collar	—	



FEATURES AND BENEFITS

- Make porches, patios, balconies and stairways more elegant and inviting.
- Variety of styles and sizes define both indoor and outdoor spaces.
- Complete systems are available.
- Most non-corrosive fasteners are concealed.
- Structurally reinforced, tough and durable.



For complete information on all Pacific Columns product categories – Louvers, E-Vents, Window and Door Trim, Mouldings, Decorative Millwork and Balustrade Systems – consult our comprehensive, full-line catalog or visit www.pacificcolumns.com.

1040 S. Melrose
Placentia, CA 92870
Phone: 1.714.630.4550
1.800.294.1098 U.S. and Canada
Fax: 1.714.630.4549 U.S. and Canada

www.pacificcolumns.com
email: sales@pacificcolumns.com

All rights reserved. Changes to the products may have been made since publication. Please consult your architectural specialist prior to ordering. ©2004 Pacific Columns, Inc. Printed in U.S.A.