

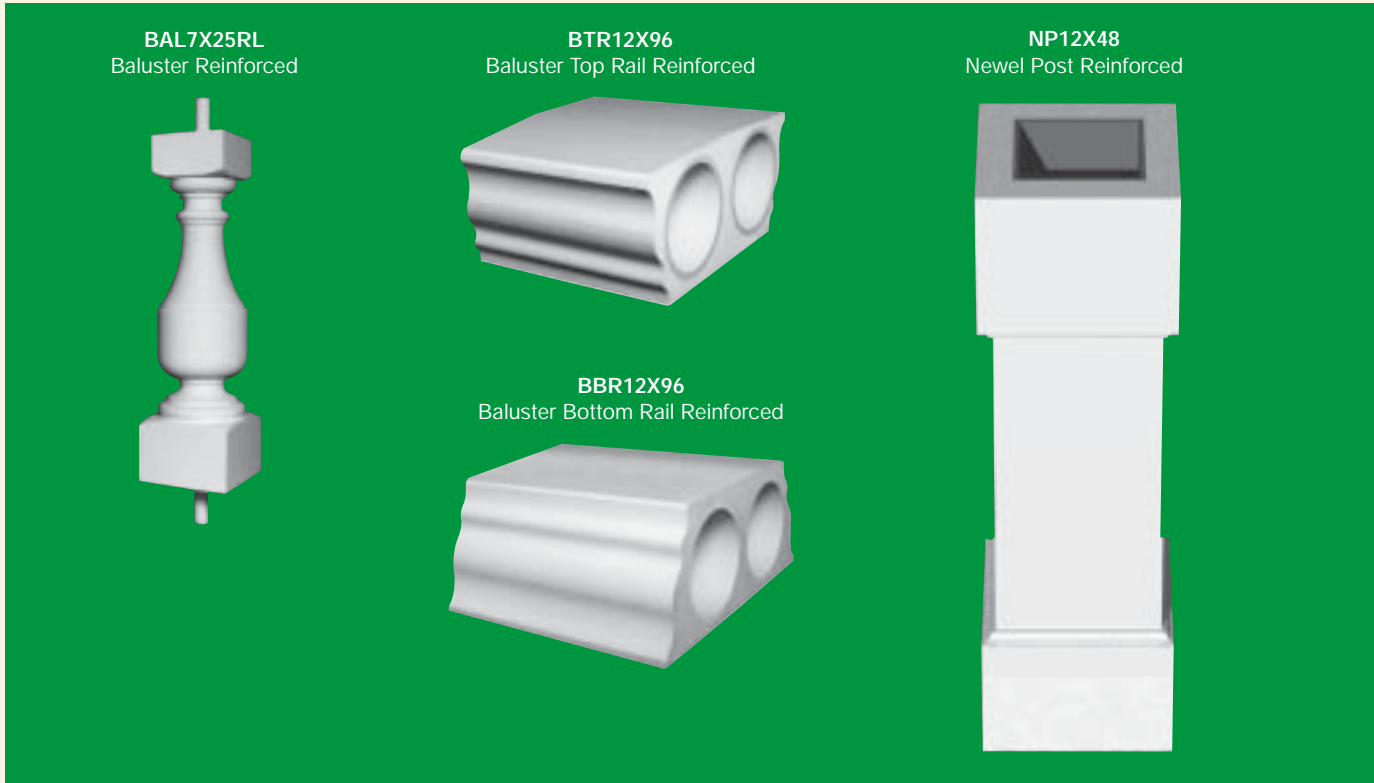

12" BALUSTRADE SYSTEM

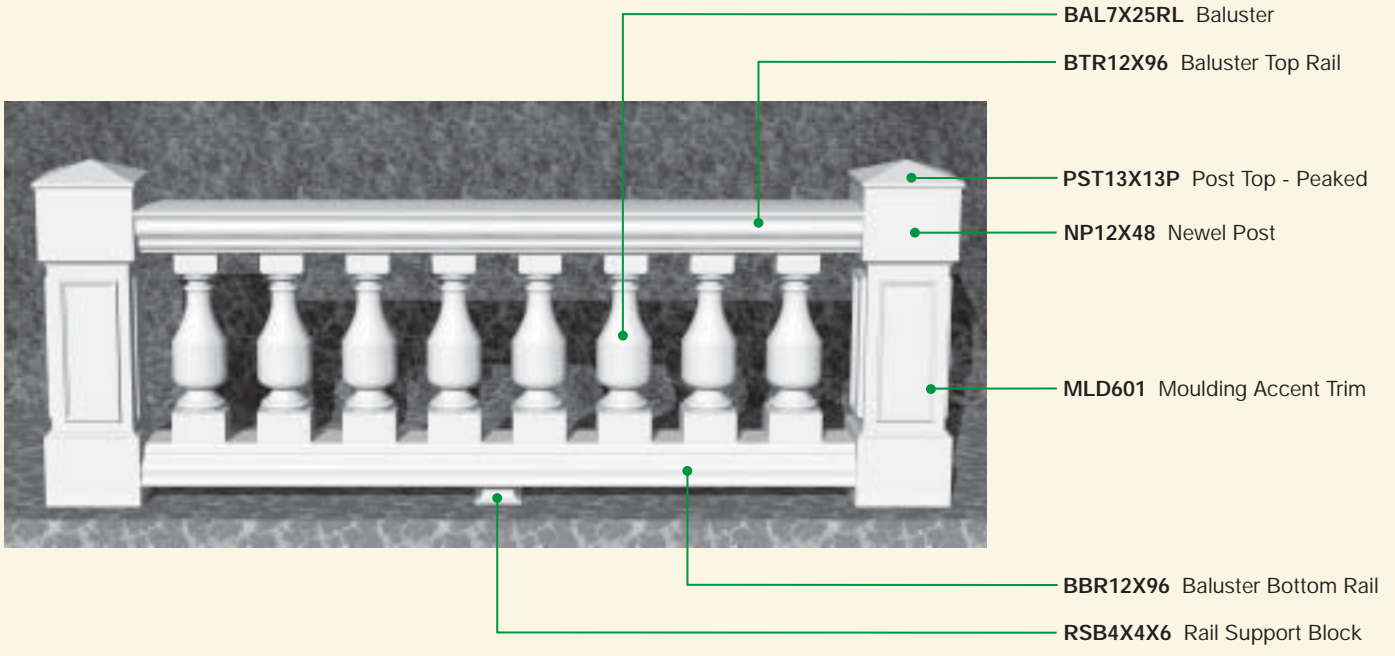

12" Balustrade System Baluster - Ashley (AY)

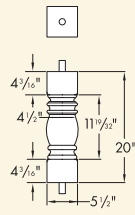

BAL6X20AY

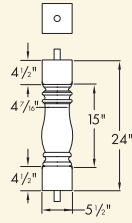

BAL6X24AY

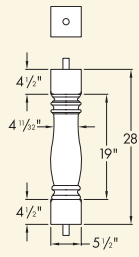

BAL6X28AY

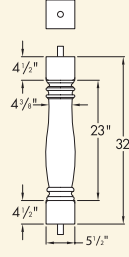

BAL6X32AY

Part Number

Maximum Center-to-Center Distance To Meet 4" Rule.
(See Page 2 BL For Details)

NEW BAL6X20AY

8 ¹⁵/₁₆"

NEW BAL6X24AY

8 ³/₈"

NEW BAL6X28AY

8 ⁹/₃₂"

NEW BAL6X32AY

8 ⁵/₁₆"

12" Balustrade System Baluster - Beaumont (BE)

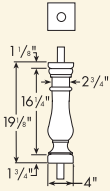

BAL4X19BE*

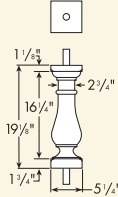

BAL5X19BE*

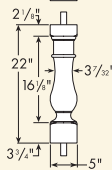

BAL5X22BE

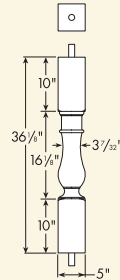

BAL5X22BETB

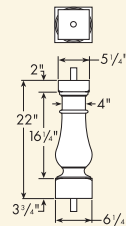

BAL6X22BE

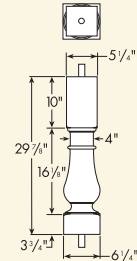

BAL6X22BET

Part Number

Maximum Center-to-Center Distance To Meet 4" Rule.
(See Page 2 BL For Details)

BAL4X19BE*

6 ⁵/₈"

BAL5X19BE*

6 ¹¹/₁₆"

NEW BAL5X22BE

7 ¹/₈"

NEW BAL5X22BETB

7 ¹/₈"

BAL6X22BE

7 ¹⁵/₁₆"

BAL6X22BET

7 ¹⁵/₁₆"

*Cannot be used for stair applications.

CHART CONTINUED ON FOLLOWING PAGE.



12" Balustrade System
Baluster - Beaumont (BE) (continued)

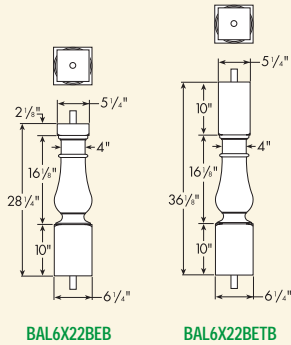

BAL6X22BEB

BAL6X22BETB

Part Number Maximum Center-to-Center Distance To Meet 4" Rule.
(See Page 2 BL For Details)

BAL6X22BEB	8 5/16"
BAL6X22BETB	7 15/16"

12" Balustrade System
Baluster - Classic (CC)

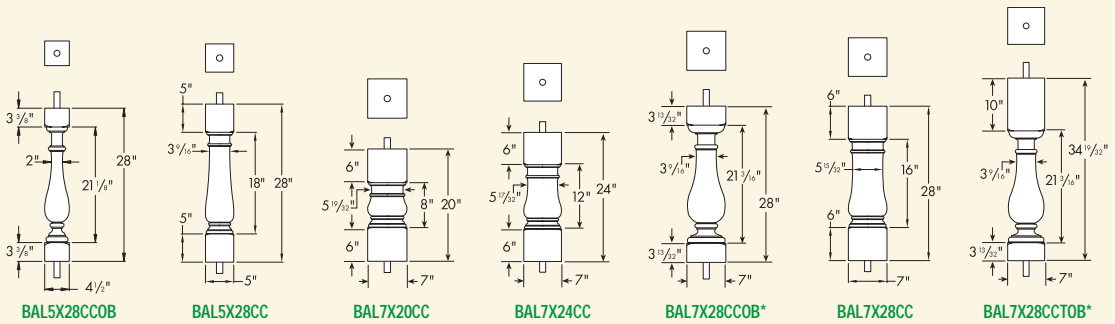

BAL5X28CCOB

BAL5X28CC

BAL7X20CC

BAL7X24CC

BAL7X28CCOB*

BAL7X28CC

BAL7X28CCTOB*

Part Number Maximum Center-to-Center Distance To Meet 4" Rule.
(See Page 2 BL For Details)

BAL5X28CCOB	5 15/16"
NEW BAL5X28CC	7 1/2"
NEW BAL7X20CC	10"
NEW BAL7X24CC	9 7/16"
BAL7X28CCOB*	7 9/16"
NEW BAL7X28CC	9 3/8"
BAL7X28CCTOB*	7 9/16"

*Cannot be used for stair applications.

CHART CONTINUED ON FOLLOWING PAGE.



12" Balustrade System Baluster - Classic (CC) (continued)

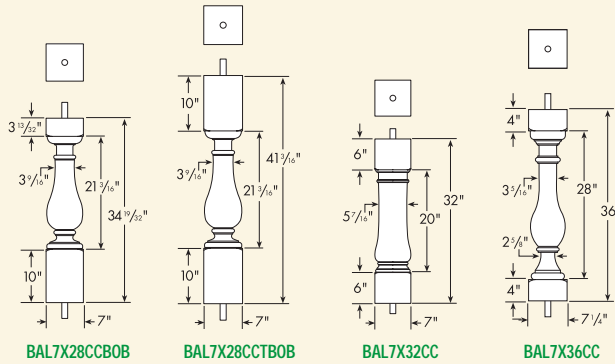

Part Number Maximum Center-to-Center Distance To Meet 4" Rule.
(See Page 2 BL For Details)

BAL7X28CCB0B	7 9/16"	
BAL7X28CCTB0B	7 9/16"	
NEW BAL7X32CC	9 3/8"	
BAL7X36CC	7 1/4"	

12" Balustrade System Baluster - Logan (LN)

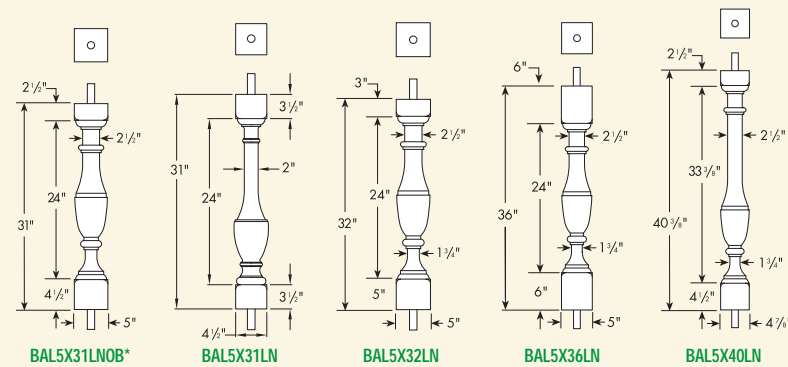

Part Number Maximum Center-to-Center Distance To Meet 4" Rule.
(See Page 2 BL For Details)

BAL5X31LNOB*	6 7/16"	
NEW BAL5X31LN	6 7/16"	
BAL5X32LN	6 7/16"	
BAL5X36LN	6 7/16"	
BAL5X40LN	6 7/16"	

*Cannot be used for stair applications.

12" Balustrade System
Baluster - Rosedale (RL)

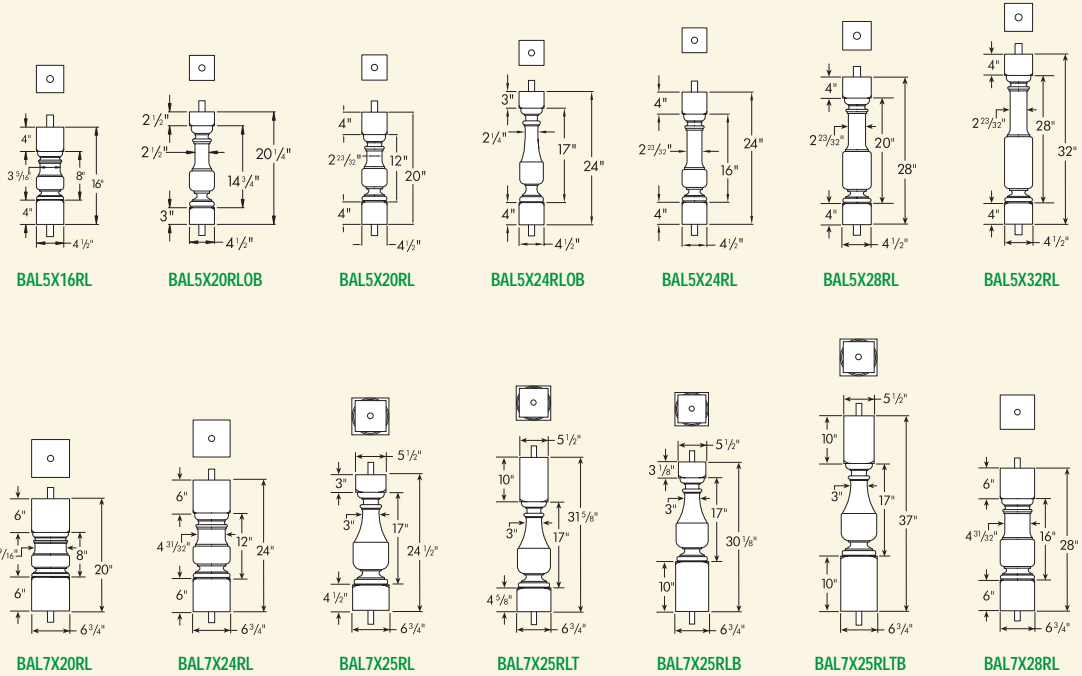

Part Number Maximum Center-to-Center Distance To Meet 4" Rule.
(See Page 2 BL For Details)

NEW BAL5X16RL	7 7/32"	
BAL5X20RLOB	6 7/16"	
NEW BAL5X20RL	6 5/8"	
BAL5X24RLOB	6 3/16"	
NEW BAL5X24RL	6 5/8"	
NEW BAL5X28RL	6 5/8"	
NEW BAL5X32RL	6 5/8"	
NEW BAL7X20RL	9 1/2"	
NEW BAL7X24RL	8 7/8"	
BAL7X25RL	6 15/16"	
BAL7X25RLT	7 1/8"	
BAL7X25RLB	7 1/16"	
BAL7X25RLTB	7 1/8"	
NEW BAL7X28RL	8 7/8"	

CHART CONTINUED ON FOLLOWING PAGE.



12" Balustrade System
Baluster - Rosedale (RL) (continued)

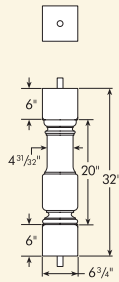

BAL7X32RL

Part Number

Maximum Center-to-Center Distance To Meet 4" Rule.
(See Page 2 BL For Details)

NEW BAL7X32RL

8 7/8"

12" Balustrade System
Baluster - Claremont (CL)

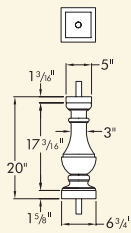

BAL6X20CL*

Part Number

Maximum Center-to-Center Distance To Meet 4" Rule.
(See Page 2 BL For Details)

BAL6X20CL*

7"

*Cannot be used for stair applications.

12" Balustrade System
Baluster - Jillian (JI)

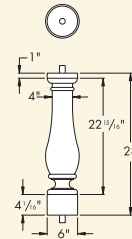

BAL6X28JI*

Part Number

Maximum Center-to-Center Distance To Meet 4" Rule.
(See Page 2 BL For Details)

NEW BAL6X28JI*

7 15/16"

*Cannot be used for stair applications.

12" Balustrade System
Baluster - Trinity (TY)

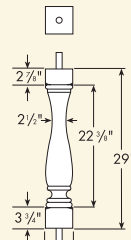

BAL5X29TY

Part Number

Maximum Center-to-Center Distance To Meet 4" Rule.
(See Page 2 BL For Details)

BAL5X29TY

6 7/16"

12" Balustrade System
Baluster - Square (SQ)

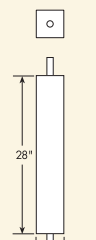

BAL5X28SQ

Part Number

Maximum Center-to-Center Distance To Meet 4" Rule.
(See Page 2 BL For Details)

NEW BAL5X28SQ

8 13/16"

12" Balustrade System Baluster - Woodruff (WF)

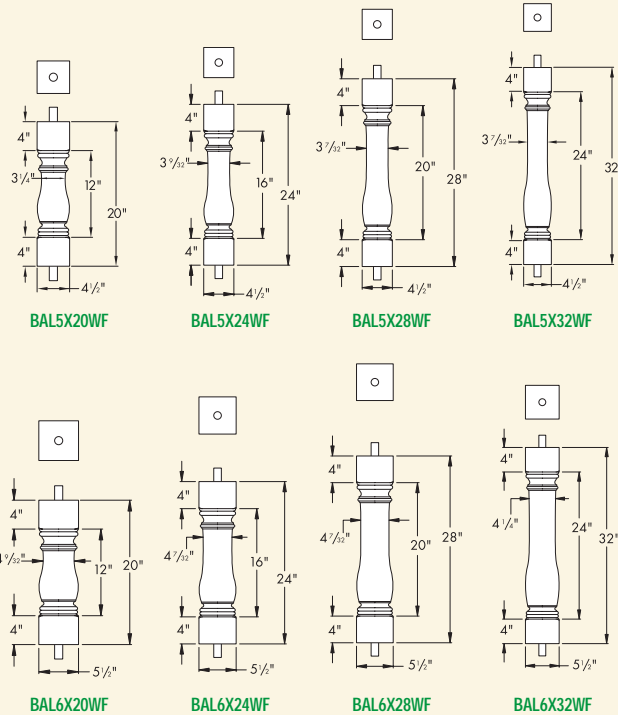

Part Number

Maximum Center-to-Center Distance To Meet 4" Rule.
(See Page 2 BL For Details)

NEW BAL5X20WF
NEW BAL5X24WF
NEW BAL5X28WF
NEW BAL5X32WF
NEW BAL6X20WF
NEW BAL6X24WF
NEW BAL6X28WF
NEW BAL6X32WF

7 ³/₁₆"
 7 ³/₈"
 7 ³/₁₆"
 7 ³/₁₆"
 8 ³/₁₆"
 8 ³/₁₆"
 8 ³/₁₆"
 8 ³/₁₆"



12" Balustrade System Top Rail

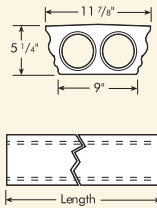

Part Number	Length	Baluster Rail Installation Kit* <small>(See Installation Guide Page 38)</small>	
BTR12X96	96"	BRK12	
BTR12X120	120"	BRK12	

*Connects both ends of one 12" Rail to applications.
 (4 qty.) Bear Claw Brackets.
 (16 qty.) #12 x 3/4" Pan Head Screws.
 (4 qty.) 3/16"-18 x 5" Hex Head Cap Screws.
 (2 qty.) 1/4"-20 x 2" Flat Head Phillips Thread Cutting Screws.
 (4 qty.) 3/16" Clip Nuts.
 (4 qty.) 1 1/2" O.D. x 3/16" I.D. x 3/64" thick Fender Washers.

12" Balustrade System Bottom Rail

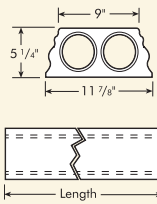

Part Number	Length	Baluster Rail Installation Kit* <small>(See Installation Guide Page 38)</small>		Rail Support Block <small>(See Below)</small>
BBR12X96	96"	BRK12		RSB4X4X6
BBR12X120	120"	BRK12		RSB4X4X6

*Connects both ends of one 12" Rail to applications.
 (4 qty.) Bear Claw Brackets.
 (16 qty.) #12 x 3/4" Pan Head Screws.
 (4 qty.) 3/16"-18 x 5" Hex Head Cap Screws.
 (2 qty.) 1/4"-20 x 2" Flat Head Phillips Thread Cutting Screws.
 (4 qty.) 3/16" Clip Nuts.
 (4 qty.) 1 1/2" O.D. x 3/16" I.D. x 3/64" thick Fender Washers.

12" Balustrade System Rail Support Block

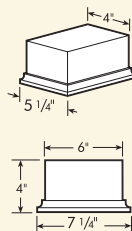
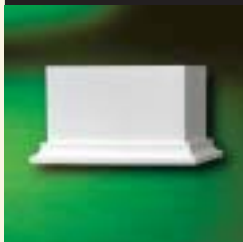

Part Number
RSB4X4X6

Rail Support Blocks should be placed under the Bottom Rail at a span of every 48" or less. These blocks can be trimmed for height.

12" Balustrade System Baluster Top Rail Radius

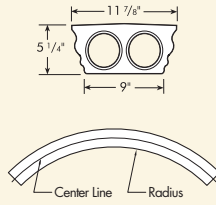

Part Number	Radius	Center Line Length	Baluster Rail Installation Kit* (See Installation Guide Page 38)
BTRR12X48	48"	75" (1/4 Circle)	BRK12
BTRR12X60	60"	94" (1/4 Circle)	BRK12
BTRR12X77	76 1/2"	122" (1/4 Circle)	BRK12
BTRR12X96	96"	120" (1/5 Circle)	BRK12
BTRR12X110	110"	78" (1/8 Circle)	BRK12
BTRR12X126	126"	102" (1/8 Circle)	BRK12
NEW BTRR12X192	192 1/2"	100" (1/12 Circle)	BRK12
BTRR12X247	246 15/16"	98" (1/16 Circle)	BRK12

*Includes hardware to mount top and bottom rail to a baluster:
 (4 qty.) Bear Claw Brackets.
 (4 qty.) 3/16"-18 Clip Nuts.
 (16 qty.) #12 x 3/4" Pan Head Screws.
 (4 qty.) 3/16"-18 x 5" Hex Head Cap Screws.
 (4 qty.) 3/16" x 1 1/2" Fender Washers.
 (4 qty.) 1/4" x 20 x 2" Flat Head Self Tapping Screws.

12" Balustrade System Baluster Bottom Rail Radius

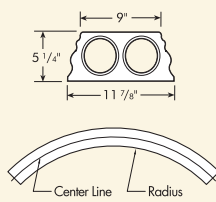

Part Number	Radius	Center Line Length	Baluster Rail Installation Kit* (See Installation Guide Page 38)	Rail Support Block (Page 32 BL)
BBRR12X48	48"	75" (1/4 Circle)	BRK12	RSB4X4X6
BBRR12X60	60"	94" (1/4 Circle)	BRK12	RSB4X4X6
BBRR12X77	76 1/2"	122" (1/4 Circle)	BRK12	RSB4X4X6
BBRR12X96	96"	120" (1/5 Circle)	BRK12	RSB4X4X6
BBRR12X110	110"	78" (1/8 Circle)	BRK12	RSB4X4X6
BBRR12X126	126"	102" (1/8 Circle)	BRK12	RSB4X4X6
NEW BBRR12X192	192 1/2"	100" (1/12 Circle)	BRK12	RSB4X4X6
BBRR12X247	246 15/16"	98" (1/16 Circle)	BRK12	RSB4X4X6

*Includes hardware to mount top and bottom rail to a baluster:
 (4 qty.) Bear Claw Brackets.
 (4 qty.) 3/16"-18 Clip Nuts.
 (16 qty.) #12 x 3/4" Pan Head Screws.
 (4 qty.) 3/16"-18 x 5" Hex Head Cap Screws.
 (4 qty.) 3/16" x 1 1/2" Fender Washers.
 (4 qty.) 1/4" x 20 x 2" Flat Head Self Tapping Screws.

12" Balustrade System Newel Post

Three piece Post reinforced, height trimable.

UNATTACHED ACCESSORIES

Newel Post Installation Kit*
(See Installation Guide Page 38)

Moulding - Miter and cut for Newel post accent.
(See Mouldings Section/Catalog Pages 26 ML-27 ML)

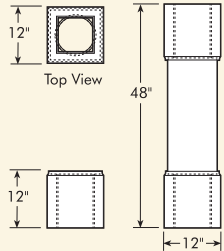

Part Number
NP12X48

NPK12

MLD601, MLD602, MLD610, MLD611

*Includes hardware to secure one NP12X48:
(2 qty.) 3/8" - 16 Hex Nuts.
(2 qty.) 3/8" - Lock Washers.
(2 qty.) 3/8" - USS Flat Washers.
(2 qty.) Corner Brackets.
(2 qty.) 3/8" - 16 x 39" Threaded Rods.
(8 qty.) #10 x 3/8" Flat Head Self Tapping Screws.
(1 qty.) Steel Base Plate.

12" Balustrade System Newel Post Accessories

Part Number

Coordinating Newel Post Accessories

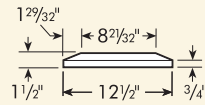

PST13X13F
Post Top - Flat

B10X13

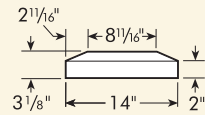

PST14X14F
Post Top - Flat

B10X13

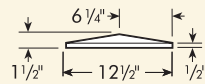

PST13X13P
Post Top - Peaked

—

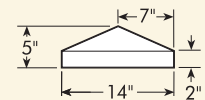

PST14X14P
Post Top - Peaked

—

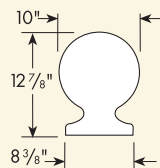

B10X13
Ball

PST13X13F
PST14X14F

FEATURES AND BENEFITS

- Make porches, patios, balconies and stairways more elegant and inviting.
- Variety of styles and sizes define both indoor and outdoor spaces.
- Complete systems are available.
- Most non-corrosive fasteners are concealed.
- Structurally reinforced, tough and durable.



For complete information on all Pacific Columns product categories – Louvers, E-Vents, Window and Door Trim, Mouldings, Decorative Millwork and Balustrade Systems – consult our comprehensive, full-line catalog or visit www.pacificcolumns.com.

1040 S. Melrose
Placentia, CA 92870
Phone: 1.714.630.4550
1.800.294.1098 U.S. and Canada
Fax: 1.714.630.4549 U.S. and Canada

www.pacificcolumns.com
email: sales@pacificcolumns.com

All rights reserved. Changes to the products may have been made since publication. Please consult your architectural specialist prior to ordering. ©2004 Pacific Columns, Inc. Printed in U.S.A.